

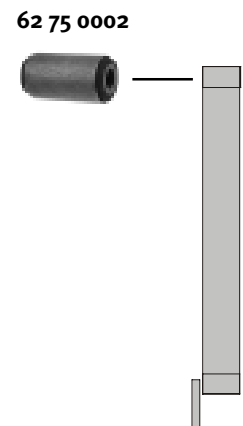

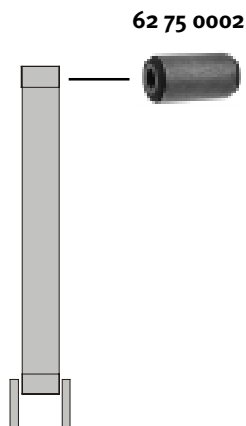
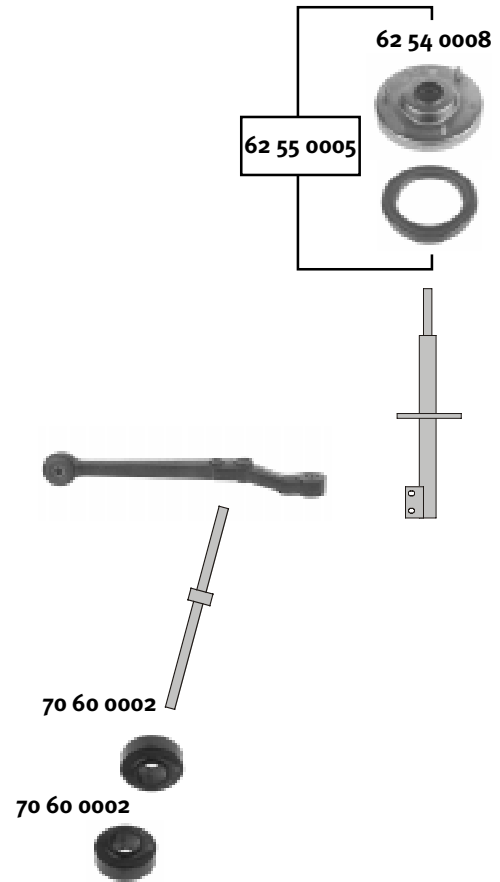
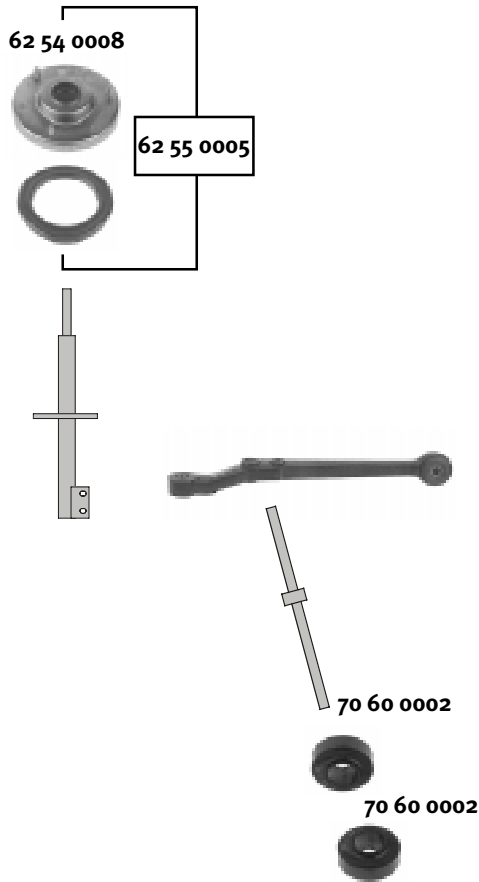

Modell
Model
Talento/Ducato

Modelljahr
Modelyear
1986 ... 1994

Quality Made For The World







	Ref.-N°.			
62 54 0008	0446 6980	Federbeinstützlager/suspension strut mount		
62 55 0005	0446 6980 S	Rep. Satz Federbeinstützlager/rep. kit suspension strut mount		
70 60 0002	0433 9248	Zugstrebenlager/tie arm bush		22 x 48 x 20,5/24,5
62 75 0002	0433 3710	Blattfederlager/leaf-spring bearing		16 x 38 x 72

Modell
Model
Ducato

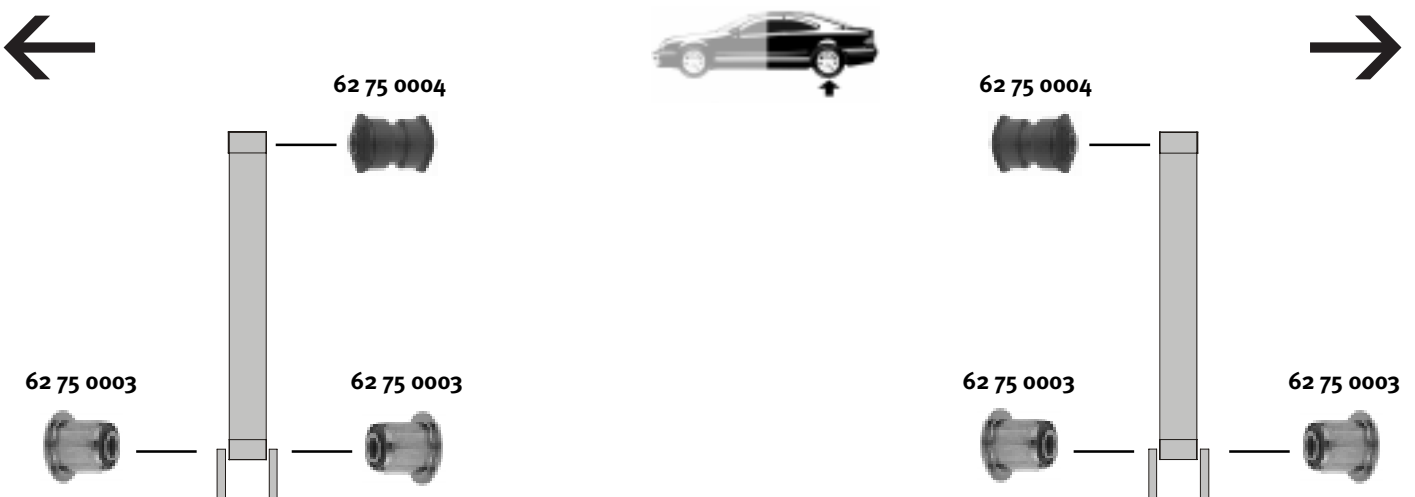
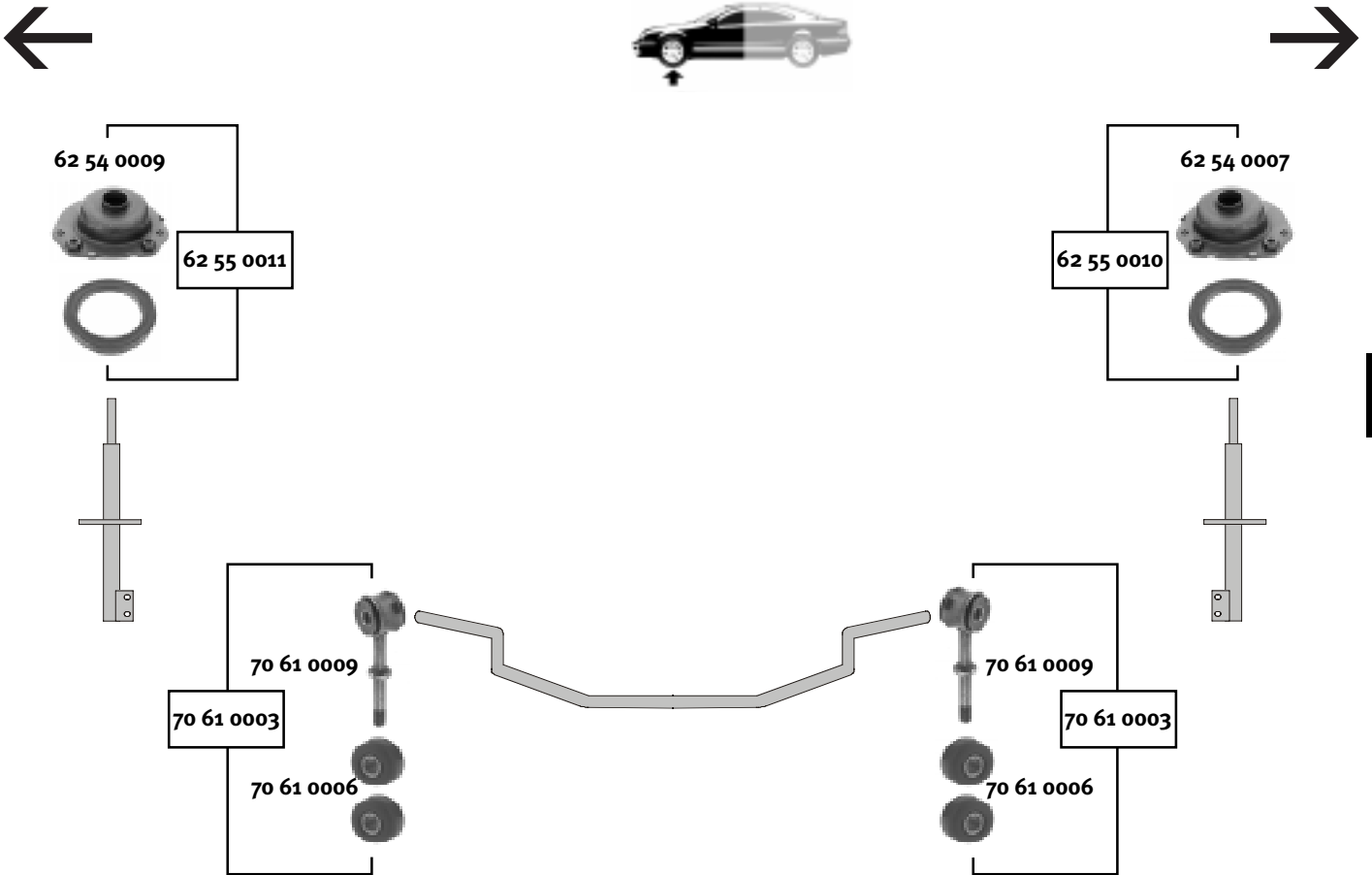
Modelljahr
Modelyear
1994 ❖❖❖

Quality Made For The World



	Ref.-N°			
62 55 0010	13072 42080 S	Rep. Satz Federbeinstützlager/rep. kit suspension strut mount		
62 55 0011	13072 41080 S	Rep. Satz Federbeinstützlager/rep. kit suspension strut mount		
62 54 0009	13072 41080	Federbeinstützlager/suspension strut mount		
62 54 0007	13072 42080	Federbeinstützlager/suspension strut mount		
70 61 0006	13130 56080	Koppelstangenlager/connecting rod bearing		12 x 37 x 22
62 75 0003	13046 40080	Blattfederlager/leaf-spring bearing		16 x 40 x 46,5
62 75 0004	13046 41080	Blattfederlager/leaf-spring bearing		16 x 50 x 87
70 61 0009	13007 16080	Koppelstange/connecting rod		
70 61 0003	13007 16080 S	Rep. Satz Koppelstange/rep. kit connecting rod		