

passend für/to fit

FIAT



Modell
Model
Uno/Fiorino

Modelljahr
Modelyear
1984 ... 1993

Quality Made For The World

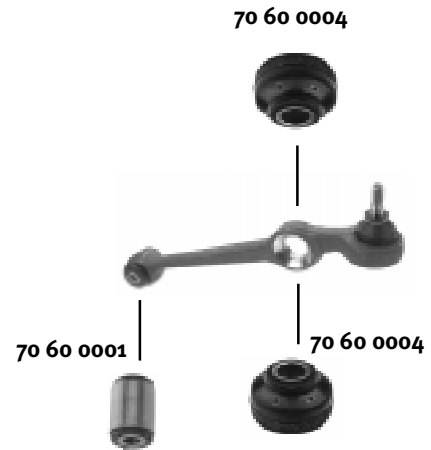
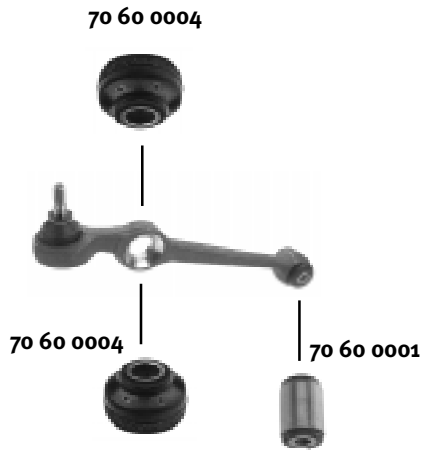

FIAT

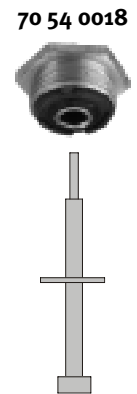
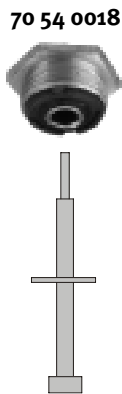

	Ref.-N°.			
70 60 0001	0767 4701	Querlenkerlager/control arm mount	(ex.) Fiorino	10 x 29 x 44
70 60 0004	0754 7438	Stabilisatorlager/stabilizier mount		14 x 44 x 25
70 54 0018	0753 7167	Federbeinstützlager/suspension strut mount		

Die Teilenummern der Automobilwerke dürfen nicht bei Berechnung an Fahrzeugbesitzer verwendet werden / It is not permitted to mention original numbers on invoices owners

Modell
Model
Uno

Modelljahr
Modelyear
1989 ••• 1995

Quality Made For The World

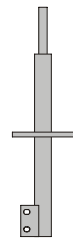
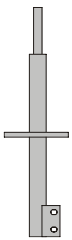
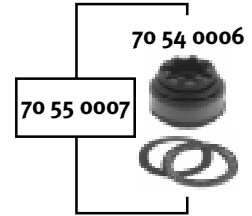
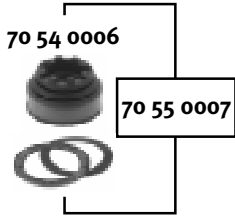

70 60 0003



70 61 0004



70 61 0004



70 60 0003





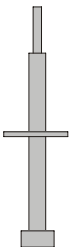

70 54 0011

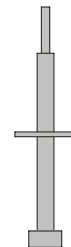

70 54 0011



	Ref.-N°			
70 54 0011	0596 0254	Federbeinstützlager/suspension strut mount	(ex.) Turbo	
70 60 0003	0756 3151	Stabilisatorlager/stabilizier mount		Ø 18
70 61 0004	0760 3476	Stabilisatorlager/stabilizier mount		
70 54 0006	0596 8311	Federbeinstützlager/suspension strut mount		
70 55 0007	0440 0895 S	Rep. Satz Federbeinstützlager/rep. kit suspension strut mount		