



**80 / 90**  
(1979 → 1987)

(ex.) Quattro



man.



(ch.) → 81-A-073 588

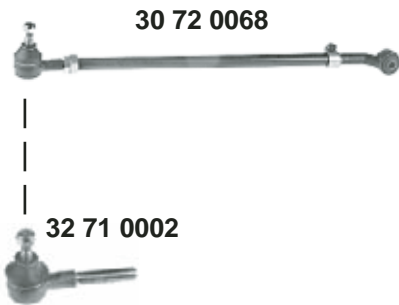

(ch.) → 81-A-073 588

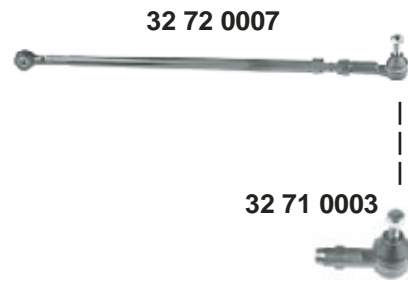
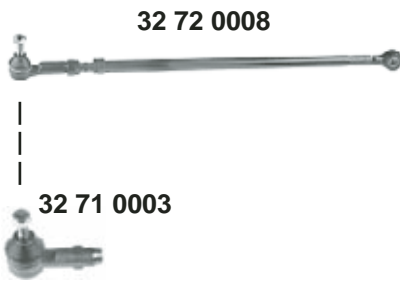

(1) (ch.) → 81/85-G-160 000



Ref. - No.



<b>30 72 0068</b>	811 419 801 B	Spurstange / tie rod	LHD	
<b>30 80 0060</b>	811 419 831 B	Lenkmanschette / steering boot		L 150
<b>32 71 0002</b>	811 419 812	Spurstangenendstück / tie rod end		M10x1
<b>32 71 0003</b>	811 419 812 A	Spurstangenendstück / tie rod end		M10x1
<b>32 72 0008</b>	811 419 801 E	Spurstange / tie rod	LHD	
<b>32 72 0007</b>	811 419 802 J	Spurstange / tie rod	LHD / (1)	



**80 / 90**  
(1979 → 1987)

(ex.) Quattro



man.



**4 cyl. alle / all**  
**5 cyl. (ch.) → 81-D-077 973**

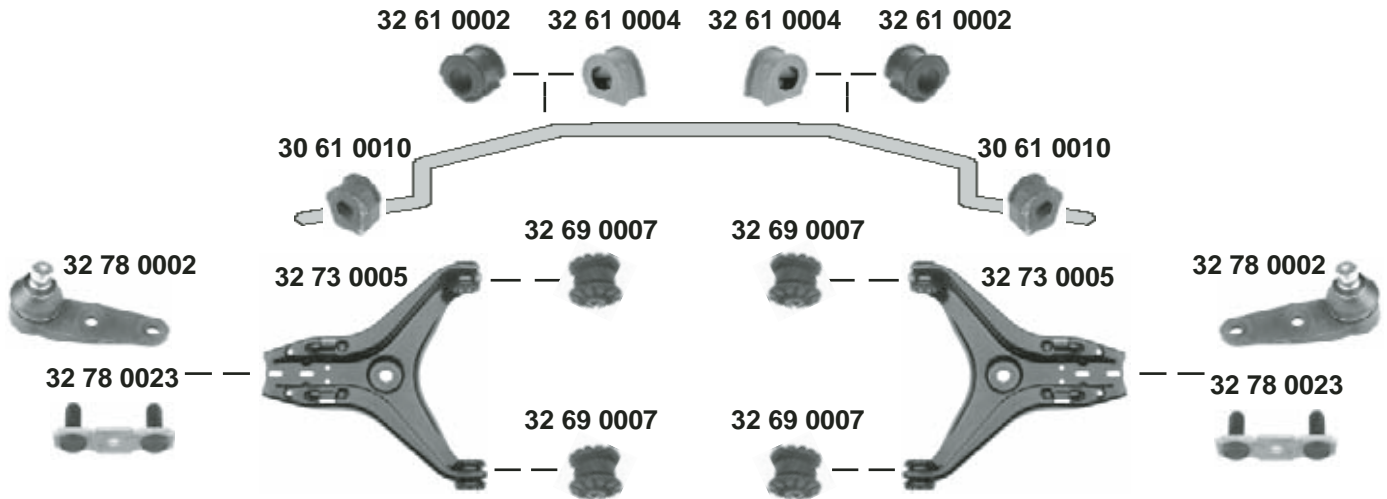

**5 cyl. (ch.) 81-D-077 974 →**

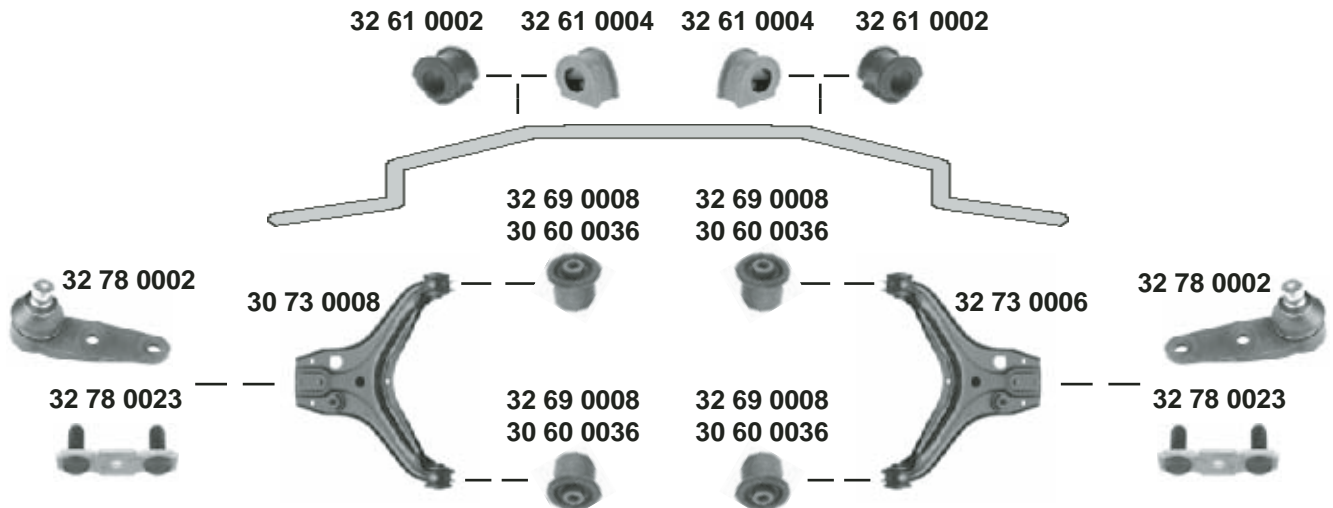

Ref. - No.



<b>30 60 0036</b>	8A0 407 181	Querlenkerlager / control arm mount
<b>30 61 0010</b>	823 411 313 A	Stabilisatorlager / stabilizer mount
<b>30 73 0008</b>	893 407 147 C	Querlenker / control arm
<b>32 61 0002</b>	811 411 327 A	Stabilisatorlager / stabilizer mount
<b>32 61 0004</b>	823 411 327 B	Stabilisatorlager / stabilizer mount
<b>32 69 0007</b>	811 407 181 A	Querlenkerlager / control arm mount
<b>32 69 0008</b>	857 407 181	Querlenkerlager / control arm mount
<b>32 73 0005</b>	893 407 147 G	Querlenker / control arm
<b>32 73 0006</b>	893 407 148 C	Querlenker / control arm
<b>32 78 0002</b>	823 407 365 E	Traggelenk / ball joint
<b>32 78 0023</b>	811 407 175 A	Sicherungsblech / lock washer

**NEW**

(ch.) **81-F-150000** →  
(ch.) → **81-D-077973**

**OLD**

(ex.) **Quattro**

10x37x44  
☒ A 12,5

☒ I 20  
☒ I 19  
10x38x44  
10x37,5x44

☒ A 17



**80 / 90**  
(1979 → 1987)

(ex.) Quattro



servo 







(ch.) → 81-A-073 588



(ch.) 81-A-073 589 →



(1) (ch.) → 81/85-G-160 000

	Ref. - No.			
<b>30 72 0068</b>	811 419 801 B	Spurstange / tie rod	LHD	L 150
<b>30 80 0060</b>	811 419 831 B	Lenkmanschette / steering boot		
<b>30 80 0061</b>	811 498 020 B	Rep. Satz Servolenkung / rep. kit power steering		
<b>32 71 0002</b>	811 419 812	Spurstangenendstück / tie rod end		M10x1
<b>32 71 0003</b>	811 419 812 A	Spurstangenendstück / tie rod end		M10x1
<b>32 72 0007</b>	811 419 802 J	Spurstange / tie rod	LHD / (1)	
<b>32 72 0008</b>	811 419 801 E	Spurstange / tie rod	LHD	



**80 / 90**  
(1979 → 1987)

(ex.) Quattro



(ch.) → 81-D-077 973

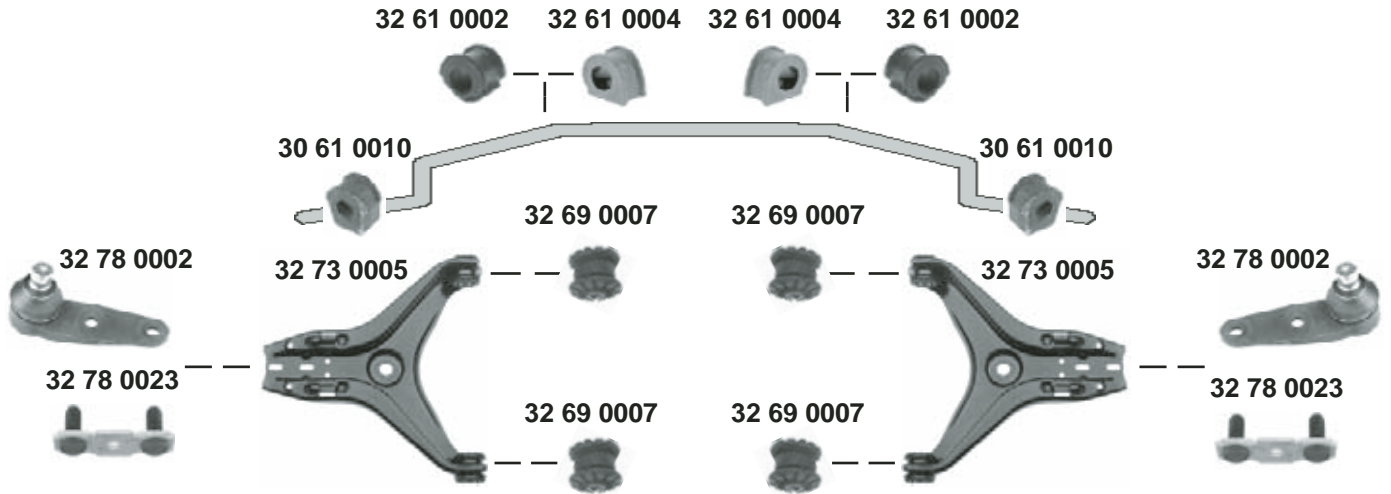

(ch.) 81-D-077 974 →

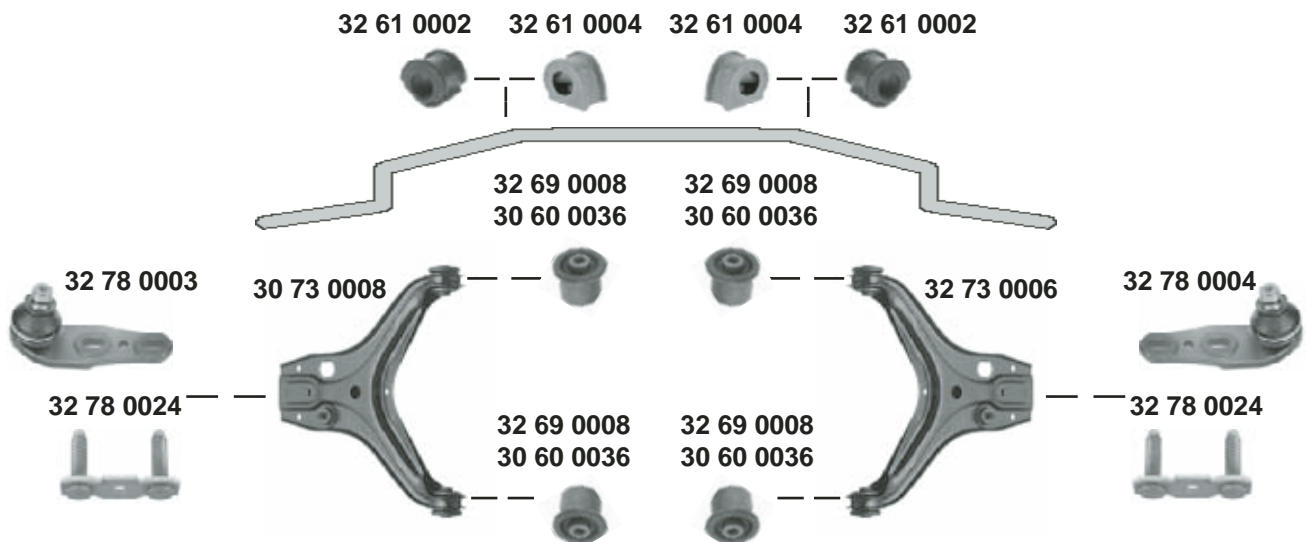

Ref. - No.



Part No.	Ref. - No.	Description	Status	Dimensions
30 60 0036	8A0 407 181	Querlenkerlager / control arm mount	NEW	10x37x44
30 61 0010	823 411 313 A	Stabilisatorlager / stabilizer mount		∅ I 12,5
30 73 0008	893 407 147 C	Querlenker / control arm		
32 61 0002	811 411 327 A	Stabilisatorlager / stabilizer mount	(ch.) 81-F-150000 →	∅ I 20
32 61 0004	823 411 327 B	Stabilisatorlager / stabilizer mount	(ch.) → 81-D-077973	∅ I 19
32 69 0007	811 407 181 A	Querlenkerlager / control arm mount		10x38x44
32 69 0008	857 407 181	Querlenkerlager / control arm mount	OLD	10x37,5x44
32 73 0005	893 407 147 G	Querlenker / control arm		
32 73 0006	893 407 148 C	Querlenker / control arm		
32 78 0002	823 407 365 E	Traggelenk / ball joint		∅ A 17
32 78 0003	855 407 365 A	Traggelenk / ball joint		∅ A 17
32 78 0004	855 407 366 A	Traggelenk / ball joint		∅ A 17
32 78 0023	811 407 175 A	Sicherungsblech / lock washer		
32 78 0024	857 407 175	Sicherungsblech / lock washer		



**80 / 90**  
(1983 → 1987)



man. 



**32 72 0008**



**32 72 0007**



**32 71 0003**



**30 80 0060**



**32 71 0003**



servo 

**32 72 0008**



**30 80 0061**



**32 72 0007**



**32 71 0003**



**30 80 0060**



**32 71 0003**



603

(1) (ch.) → 81/85-G-160 000



Ref. - No.



<b>30 80 0060</b>	811 419 831 B
<b>30 80 0061</b>	811 498 020 B
<b>32 71 0002</b>	811 419 812
<b>32 71 0003</b>	811 419 812 A
<b>32 72 0007</b>	811 419 802 J
<b>32 72 0008</b>	811 419 801 E

Lenkmanschette / steering boot
Rep. Satz Servolenkung / rep. kit power steering
Spurstangenendstück / tie rod end
Spurstangenendstück / tie rod end
Spurstange / tie rod
Spurstange / tie rod

LHD / (1)  
LHD

L 150  
M10x1  
M10x1



**80 / 90**  
(1983 → 1987)

(ex.) Quattro



4 cyl. man.

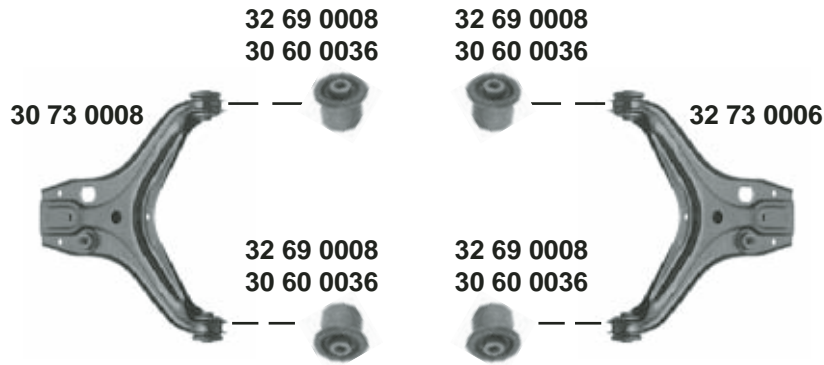

4 cyl. servo   
5 cyl. alle / all

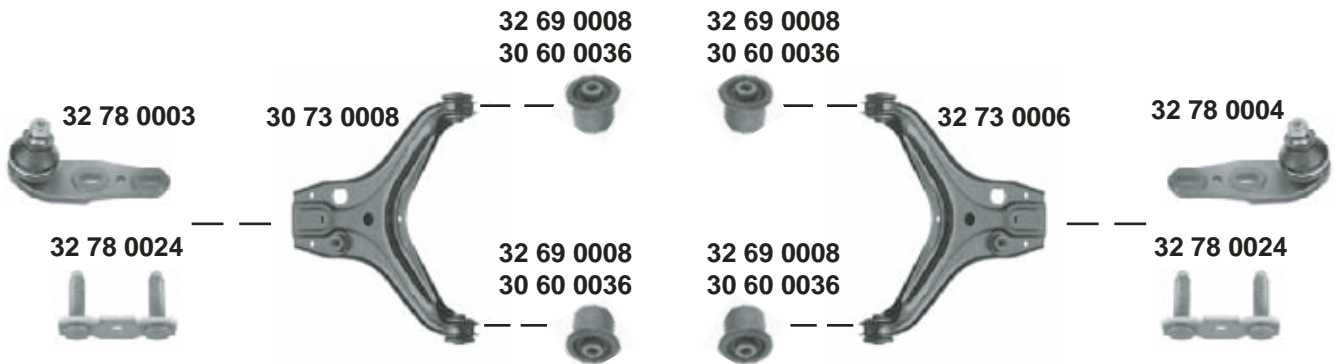

Ref. - No.



<b>30 60 0036</b>	8A0 407 181	Querlenkerlager / control arm mount	<b>NEW</b>	10x37x44
<b>30 73 0008</b>	893 407 147 C	Querlenker / control arm		
<b>32 69 0008</b>	857 407 181	Querlenkerlager / control arm mount	<b>OLD</b>	10x37,5x44
<b>32 73 0006</b>	893 407 148 C	Querlenker / control arm		
<b>32 78 0003</b>	855 407 365 A	Traggelenk / ball joint		☒ A 17
<b>32 78 0004</b>	855 407 366 A	Traggelenk / ball joint		☒ A 17
<b>32 78 0024</b>	857 407 175	Sicherungsblech / lock washer		







**80 / 90**  
(1987 → 1992)

(ex.) Quattro

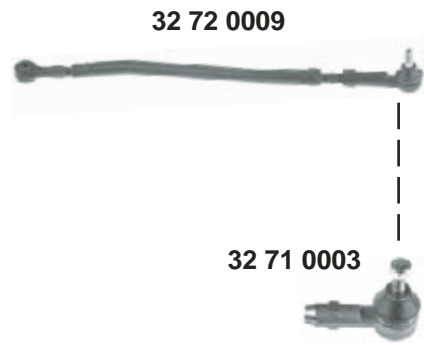
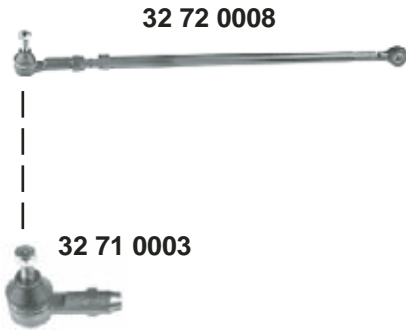

man. 



	Ref. - No.			
<b>30 80 0060</b>	811 419 831 B	Lenkmanschette / steering boot		L 150
<b>32 71 0003</b>	811 419 812 A	Spurstangenendstück / tie rod end		M10x1
<b>32 72 0008</b>	811 419 801 E	Spurstange / tie rod	LHD	
<b>32 72 0009</b>	893 419 802	Spurstange / tie rod	LHD	



**80 / 90**  
(1987 → 1992)

(ex.) Quattro



man.



**4 cyl.**

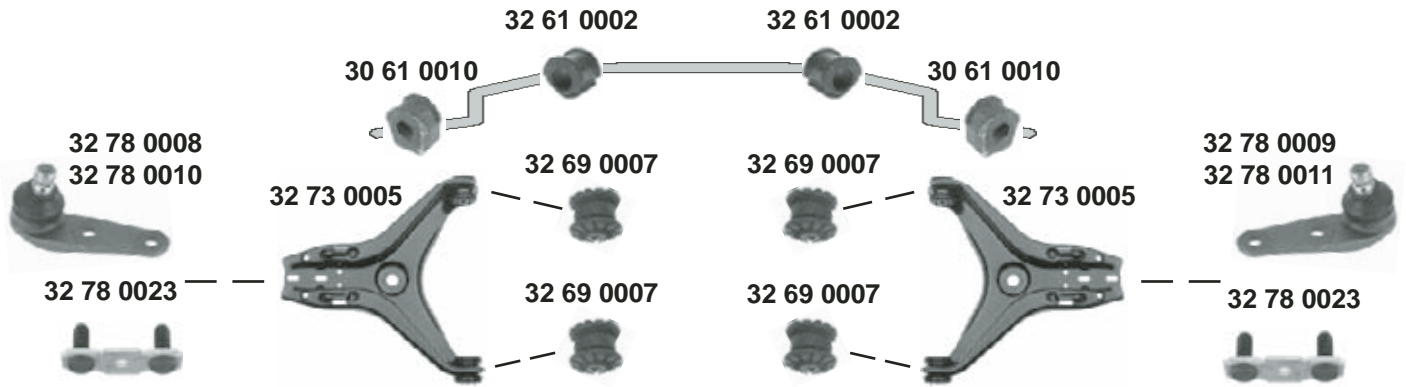

**5 cyl.**

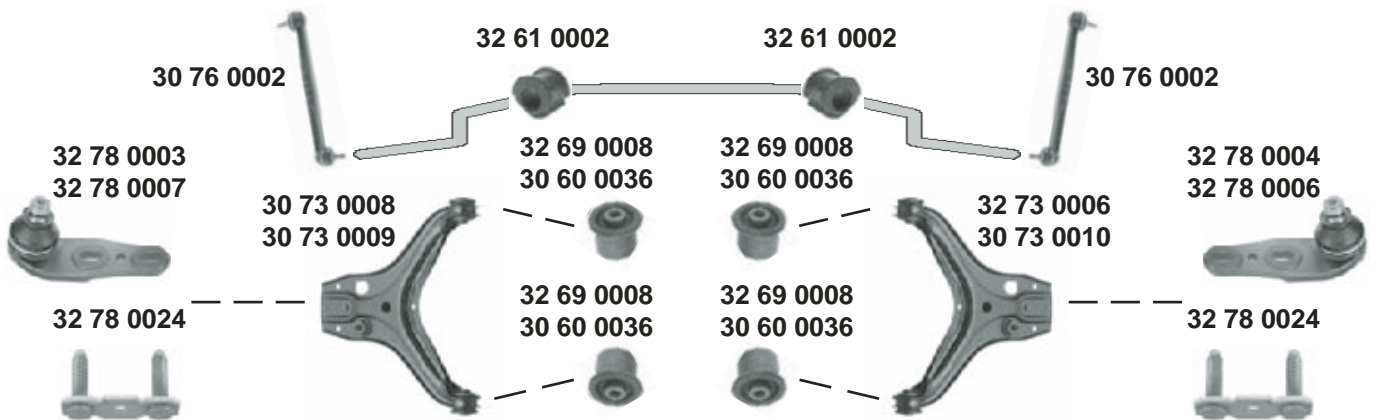

Ref. - No.



<b>30 60 0036</b>	8A0 407 181	Querlenkerlager / control arm mount	<b>NEW</b>	10x37x44
<b>30 61 0010</b>	823 411 313 A	Stabilisatorlager / stabilizer mount		∩ I 12,5
<b>30 73 0008</b>	893 407 147 C	Querlenker / control arm	(ch.) → <b>8A-L-038 656</b>	
<b>30 73 0009</b>	893 407 147 E	Querlenker / control arm	(ch.) <b>8A-L-038 657</b> →	
<b>30 73 0010</b>	893 407 148 E	Querlenker / control arm	(ch.) <b>8A-L-038 657</b> →	
<b>30 76 0002</b>	8A0 407 465	Verbindungsstange / connecting rod	(ch.) <b>8A-L-038 758</b> →	L 269,5
<b>32 61 0002</b>	811 411 327 A	Stabilisatorlager / stabilizer mount	(ch.) → <b>8A-L-038 757</b>	∩ I 20
<b>32 69 0007</b>	811 407 181 A	Querlenkerlager / control arm mount	<b>OLD</b>	10x38x44
<b>32 69 0008</b>	857 407 181	Querlenkerlager / control arm mount		10x37,5x44
<b>32 73 0005</b>	893 407 147 G	Querlenker / control arm	(ch.) → <b>8A-L-038 656</b>	
<b>32 73 0006</b>	893 407 148 C	Querlenker / control arm	(ch.) → <b>89-J-373 598</b>	∩ A 17
<b>32 78 0003</b>	855 407 365 A	Traggelenk / ball joint	(ch.) → <b>89-J-373 598</b>	∩ A 17
<b>32 78 0004</b>	855 407 366 A	Traggelenk / ball joint	(ch.) <b>89-J-373 599</b> →	∩ A 19
<b>32 78 0006</b>	893 407 366 F	Traggelenk / ball joint	(ch.) <b>89-J-373 599</b> →	∩ A 19
<b>32 78 0007</b>	893 407 365 F	Traggelenk / ball joint	(ch.) <b>89-J-373 599</b> →	∩ A 19
<b>32 78 0008</b>	855 407 365	Traggelenk / ball joint	(ch.) → <b>89-J-373 598</b>	∩ A 17
<b>32 78 0009</b>	855 407 366	Traggelenk / ball joint	(ch.) → <b>89-J-373 598</b>	∩ A 17
<b>32 78 0010</b>	893 407 365 A	Traggelenk / ball joint	(ch.) <b>89-J-373 599</b> →	∩ A 19
<b>32 78 0011</b>	893 407 366 A	Traggelenk / ball joint	(ch.) <b>89-J-373 599</b> →	∩ A 19
<b>32 78 0023</b>	811 407 175 A	Sicherungsblech / lock washer		
<b>32 78 0024</b>	857 407 175	Sicherungsblech / lock washer		



**80 / 90**  
(1987 → 1992)



servo 

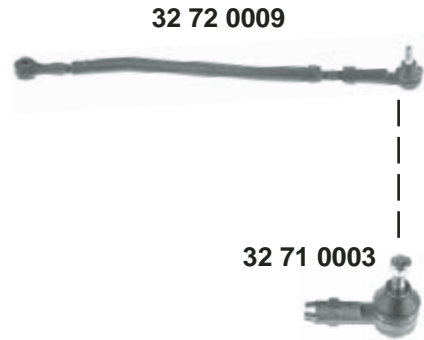
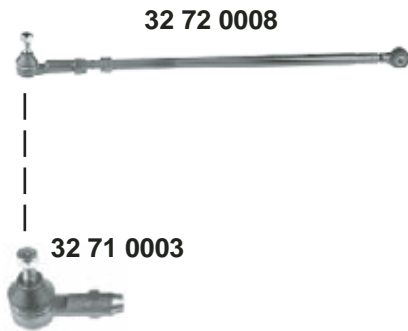

Ref. - No.



<b>30 80 0060</b>	811 419 831 B	Lenkmanschette / steering boot		
<b>30 80 0061</b>	811 498 020 B	Rep. Satz Servolenkung / rep. kit power steering		
<b>32 71 0003</b>	811 419 812 A	Spurstangenendstück / tie rod end		
<b>32 72 0008</b>	811 419 801 E	Spurstange / tie Rod	<b>LHD</b>	
<b>32 72 0009</b>	893 419 802	Spurstange / tie rod	<b>LHD</b>	

L 150

M10x1



**80 / 90**  
(1987 → 1992)

(ex.) Quattro



servo



(ex.) 2.3 20V (7A)

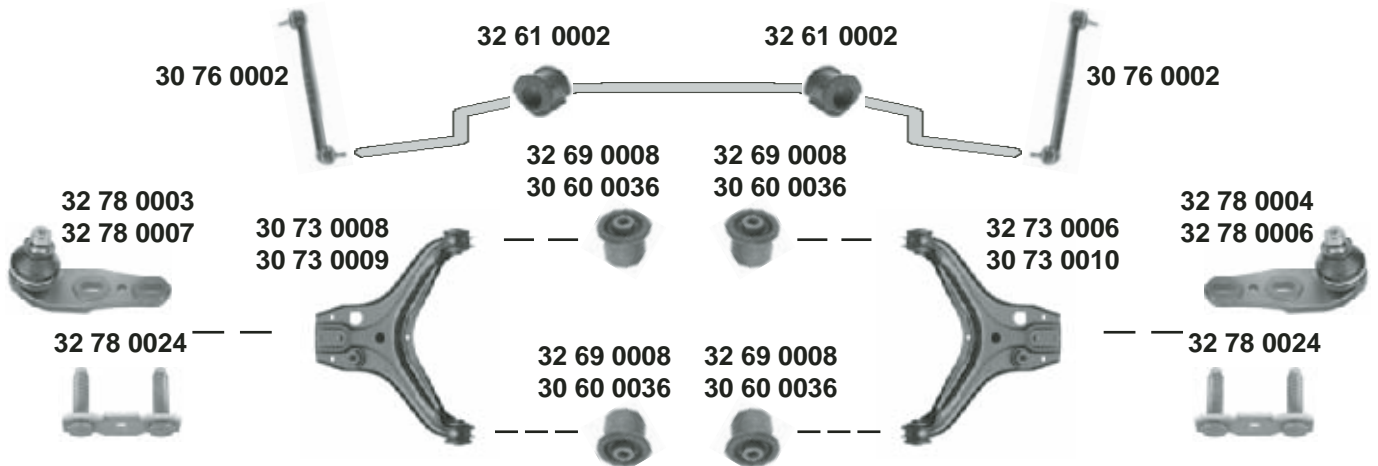

2.3 20V (7A)

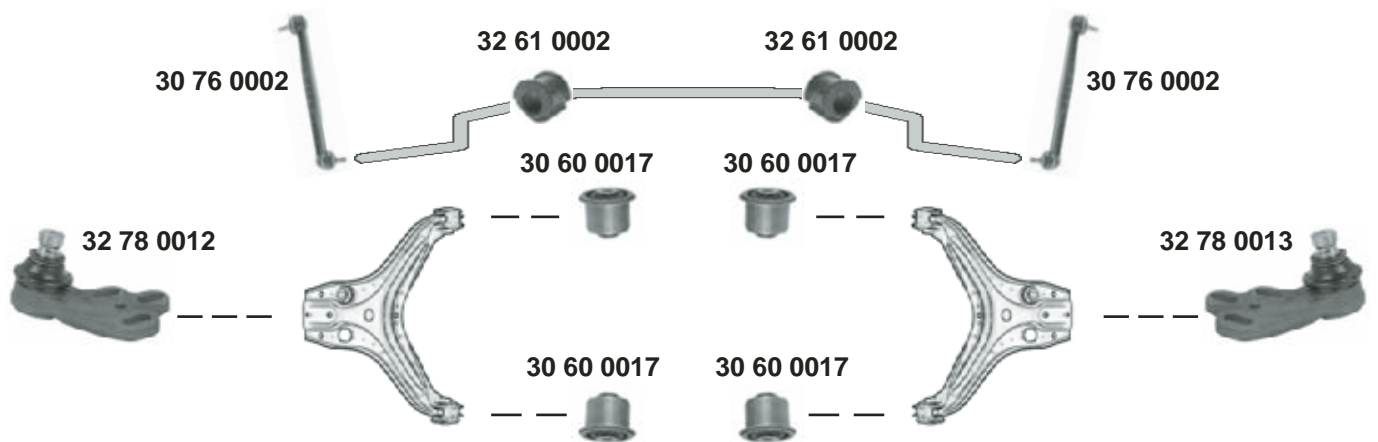

Ref. - No.



<b>30 60 0017</b>	893 407 181	Querlenkerlager / control arm mount		10x44x44
<b>30 60 0036</b>	8A0 407 181	Querlenkerlager / control arm mount	<b>NEW</b>	10x37x44
<b>30 73 0008</b>	893 407 147 C	Querlenker / control arm	(ch.) → <b>8A-L-038656</b>	
<b>30 73 0009</b>	893 407 147 E	Querlenker / control arm	(ch.) <b>8A-L-038657</b> →	
<b>30 73 0010</b>	893 407 148 E	Querlenker / control arm	(ch.) <b>8A-L-038657</b> →	
<b>30 76 0002</b>	8A0 407 465	Verbindungsstange / connecting rod	(ch.) <b>8A-L-038 758</b> →	L 269,5
<b>32 61 0002</b>	811 411 327 A	Stabilisatorlager / stabilizer mount	(ch.) → <b>8A-L-038757</b>	∅ I 20
<b>32 69 0008</b>	857 407 181	Querlenkerlager / control arm mount	<b>OLD</b>	10x37,5x44
<b>32 73 0006</b>	893 407 148 C	Querlenker / control arm	(ch.) → <b>8A-L-038656</b>	
<b>32 78 0003</b>	855 407 365 A	Traggelenk / ball joint	(ch.) → <b>89-J-373598</b>	∅ A 17
<b>32 78 0004</b>	855 407 366 A	Traggelenk / ball joint	(ch.) → <b>89-J-373598</b>	∅ A 17
<b>32 78 0006</b>	893 407 366 F	Traggelenk / ball joint	(ch.) <b>89-J-373599</b> →	∅ A 19
<b>32 78 0007</b>	893 407 365 F	Traggelenk / ball joint	(ch.) <b>89-J-373599</b> →	∅ A 19
<b>32 78 0012</b>	893 407 365 E	Traggelenk / ball joint		∅ A 19
<b>32 78 0013</b>	893 407 366 E	Traggelenk / ball joint		∅ A 19
<b>32 78 0024</b>	857 407 175	Sicherungsblech / lock washer		



**80 / 90**  
(1987 → 1992)



man.



**32 72 0008**



**32 71 0003**



**30 80 0060**



**32 72 0009**



**32 71 0003**



servo

**32 72 0008**



**32 71 0003**



**30 80 0061**



**30 80 0060**



**32 72 0009**



**32 71 0003**



603



Ref. - No.



**30 80 0060**  
**30 80 0061**  
**32 71 0003**  
**32 72 0008**  
**32 72 0009**

811 419 831 B  
811 498 020 B  
811 419 812 A  
811 419 801 E  
893 419 802

Lenkmanschette / steering boot  
Rep. Satz Servolenkung / rep. kit power steering  
Spurstangenendstück / tie rod end  
Spurstange / tie Rod  
Spurstange / tie rod

LHD  
LHD

L 150  
M10x1



**80 / 90**  
(1987 → 1992)

**Quattro**

(ex.) **2.3 20V (7A)**

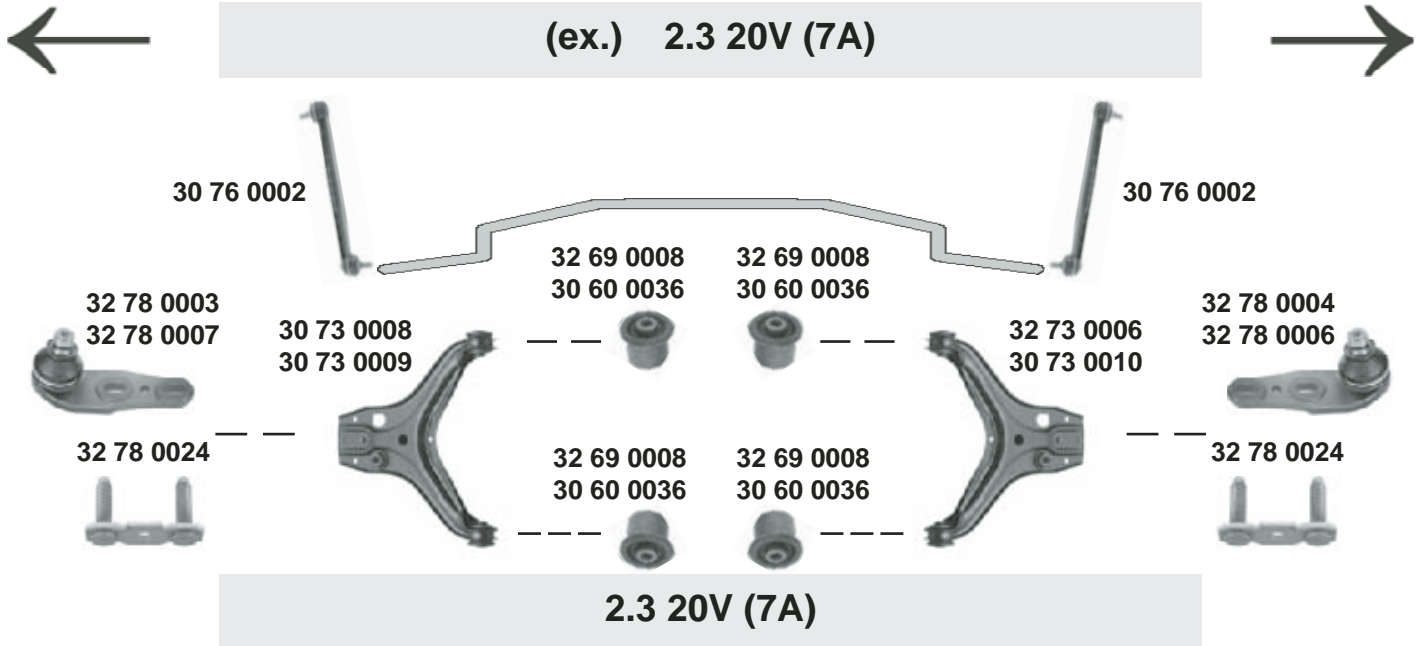

**2.3 20V (7A)**

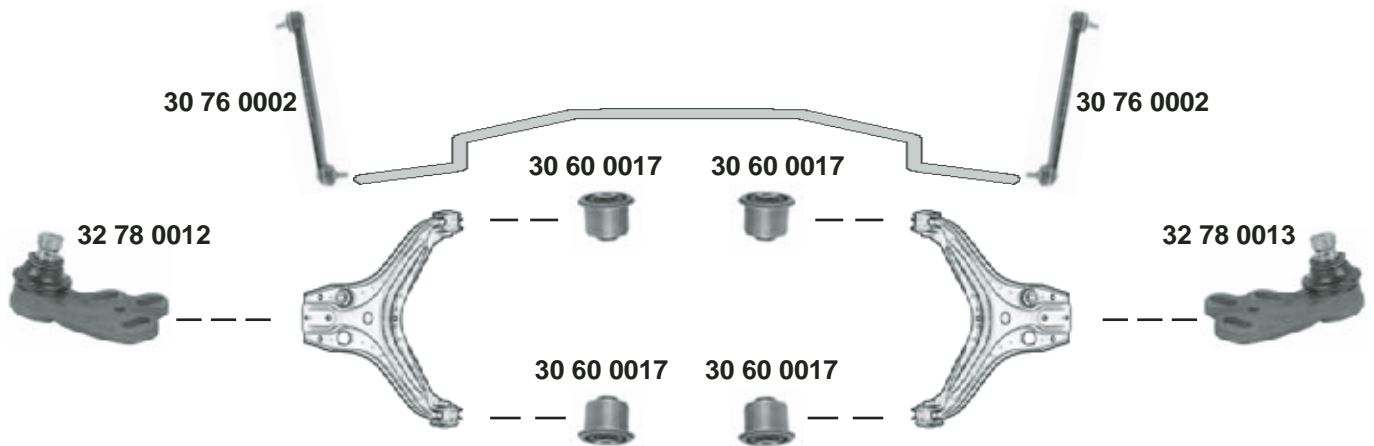

Ref. - No.



<b>30 60 0017</b>	893 407 181	Querlenkerlager / control arm mount		10x44x44
<b>30 60 0036</b>	8A0 407 181	Querlenkerlager / control arm mount		10x37x44
<b>30 73 0008</b>	893 407 147 C	Querlenker / control arm		
<b>30 73 0009</b>	893 407 147 E	Querlenker / control arm		
<b>30 73 0010</b>	893 407 148 E	Querlenker / control arm		
<b>30 76 0002</b>	8A0 407 465	Verbindungsstange / connecting rod		L 269,5
<b>32 69 0008</b>	857 407 181	Querlenkerlager / control arm mount		10x37,5x44
<b>32 73 0006</b>	893 407 148 C	Querlenker / control arm		
<b>32 78 0003</b>	855 407 365 A	Traggelenk / ball joint		☒ A 17
<b>32 78 0004</b>	855 407 366 A	Traggelenk / ball joint		☒ A 17
<b>32 78 0006</b>	893 407 366 F	Traggelenk / ball joint		☒ A 19
<b>32 78 0007</b>	893 407 365 F	Traggelenk / ball joint		☒ A 19
<b>32 78 0012</b>	893 407 365 E	Traggelenk / ball joint		☒ A 19
<b>32 78 0013</b>	893 407 366 E	Traggelenk / ball joint		☒ A 19
<b>32 78 0024</b>	857 407 175	Sicherungsblech / lock washer		

**NEW**

(ch.) → 8A-L-045000

(ch.) 8A-L-045001 →

(ch.) 8A-L-045001 →

(ch.) 8A-L-038 758 →

**OLD**

(ch.) → 8A-L-045000

(ch.) → 89-J-351000

(ch.) → 89-J-351000

(ch.) 89-J-351001 →

(ch.) 89-J-351001 →

(ch.) 8A-L-045001 →

(ch.) 8A-L-045001 →